



ADVANCED
ENERGY MINERALS

Investor Presentation

May 2026

Important Notices and Disclaimer

This presentation (**Presentation**) is dated [insert] and has been prepared by Advanced Energy Minerals Ltd (ACN 095 907 565) (**AEM** or the **Company**) and provides general information about the Company and its business.

Information in this Presentation

The information in this Presentation is of a general background nature, is in summary form and does not purport to be complete or comprise all information regarding AEM. The information contained in this Presentation is current as at the date of this Presentation or such earlier date as specified in this Presentation.

The information in this Presentation is subject to change without notice. No representation or warranty, express or implied, is made by AEM or any of its advisers as to the accuracy, adequacy, completeness or reliability of any statements, estimates, opinions, forecasts, reports or other information contained in this Presentation. This Presentation is not a prospectus, product disclosure statement or other disclosure document for the purposes of Chapter 6D or Part 7.9 of the Corporations Act or other offer document under Australian law or the law of any other jurisdiction, including the United States and does not purport to contain all of the information that is required to be included in such documents, including all information about the assets and liabilities, financial position and performance, profits and losses, prospects, and the rights and liabilities attaching to securities.

Not Financial or Product Advice

This Presentation is for information purposes only and does not contain or purport to contain, an offer, invitation, solicitation or recommendation to subscribe for or purchase or sell any securities in AEM in any jurisdiction. This Presentation is not intended to be, and does not constitute, legal, taxation, financial product or investment advice or a recommendation to acquire securities in AEM. This Presentation will not be lodged with, approved by or registered with the Australian Securities and Investments Commission (**ASIC**) or any other regulator in any jurisdiction. It has been prepared without taking into account the objectives, financial situation or needs of any person. A recipient of this Presentation is solely responsible for forming their own opinions and conclusions on matters and for making their own independent assessment of the information provided and in the case of any doubt should consult a financial, legal or other adviser.

No Distribution

This Presentation has been prepared for publication in Australia and may not be released to US wire services or distributed in the United States. This Presentation does not constitute an offer to sell, or a solicitation of an offer to buy, securities in the United States or any other jurisdiction.

No securities of AEM have been, nor will be, registered under the US Securities Act of 1933 or the securities laws of any state or other jurisdiction of the United States, and no securities of AEM may be offered or sold in the United States except in transactions exempt from, or not subject to, the registration requirements of the US Securities Act and applicable US state securities laws.

Persons who come into possession of this Presentation should observe any such restrictions as any noncompliance could contravene applicable securities laws.

Future Performance

The Presentation contains certain "forward-looking statements". The words "forecast", "expect", "anticipate", "estimate", "intend", "believe", "guidance", "should", "could", "may", "will", "target", "predict", "plan" and other similar expressions are intended to identify forward-looking statements. Indications of, and guidance on, future earnings and financial position and performance are also forward-looking statements. Forward-looking statements, opinions and estimates provided in this Presentation are based on assumptions and contingencies which are subject to change without notice and involve known and unknown risks and certainties and other factors which are beyond the control of AEM, and its directors and management, and may involve significant elements of subjective judgement and assumptions as to future events which may or may not be correct. This includes statements about market and industry trends, which are based on interpretations of current market conditions.

Forward-looking statements are provided as a general guide only and should not be relied upon as an indication or guarantee of future performance. Actual results, performance or achievements may differ materially from those expressed or implied in such statements and any contingencies and assumptions on which these statements are based. Recipients are cautioned not to place undue reliance on forward-looking statements and except as required by law, no representation or warranty, express or implied, is made as to the accuracy, likelihood of achievement or reasonableness of any forecasts, prospects, assumptions, returns, contingencies or statements in relation to future matters contained in this Presentation. The forward-looking statements are based on information available to AEM as at the date of this Presentation. Except as required by law, none of AEM, its representatives or advisers undertakes any obligation to provide any additional or updated information whether as a result of a change in expectations or assumptions, new information, future events or results or otherwise. Indications of, and guidance or outlook on, future earnings or financial position or performance are also forward-looking statements.



Important Notices and Disclaimer (cont.)

No Warranty and Disclaimer

No party other than AEM has authorised or caused the issue, lodgement, submission, dispatch or provision of this Presentation, or takes any responsibility for, or makes or purports to make any statements, representations or undertakings in this Presentation. To the maximum extent permitted by law, AEM including its subsidiaries, related bodies corporate, shareholders, affiliates, advisers and agents (each a **Limited Party**):

- disclaims all responsibility and liability (including, without limitation, any liability arising from fault, negligence or negligent misstatement) for any direct, indirect, consequential loss, damage, expense or cost arising from any statements, representations or warranties or in relation to the accuracy or completeness of the information, statements, opinions or matters, express or implied, contained in, arising out of or derived from, or for omissions from, this Presentation including, without limitation, any financial information, any estimates or projections and any other financial information derived therefrom;
- disclaims any obligation or undertaking to release any updates or revision to the information in this Presentation to reflect any change in expectations or assumptions or inform you of any new or more accurate information or any errors, omissions or mis-descriptions of which a Limited Party may become aware;
- does not make any representation or warranty, express or implied, as to the accuracy, reliability, currency or completeness of the information in this Presentation or the likelihood of achievement of any forward-looking statement or any event or results expressed or implied in any forward-looking statement; and
- does not represent or warrant that this Presentation is complete or that it contains all material information about AEM or which a prospective investor may require in evaluating a possible investment in AEM.

Recipients must conduct their own independent investigations and enquiries as they deem fit.

Past Performance

Past performance information given in this Presentation is given for illustrative purposes only and should not be relied upon as (and is not) an indication of AEM's views, or that of any party involved in its preparation, on AEM's future performance, condition or prospects.

Effect of Rounding

A number of figures, amounts, percentages, estimates, calculations of value and fractions in this Presentation are subject to the effect of rounding. Accordingly, the actual calculation of these figures may differ from the figures set out in this Presentation assumptions.

Market and Industry Data and Other Information

Certain market and industry data and other information used in this Presentation may have been obtained from research, surveys or studies conducted by third parties, including industry or general publications. Neither the Company nor its representatives or its advisers have independently verified, or can assure investors as to the accuracy of, any market or industry data or other information provided by third parties or industry or general publications. The Company's internally generated data is based on estimates and assumptions that the directors and management of the Company believe are reasonable.

Photographs and diagrams used in this Presentation that do not have descriptions are for illustration only and should not be interpreted to mean that any person shown in them endorses this Presentation or its contents or that the assets shown in them are owned by the Company.

The photographs contained in this Presentation are the property of or are licensed to AEM and are protected under copyright laws. No permission is granted for the reproduction of these photographs outside of their appearance in this Presentation. Diagrams used in this Presentation are illustrative only and may not be drawn to scale.

General

Statements made in this Presentation are made only as at the date of this Presentation. The information in this Presentation remains subject to change without notice. The Company may in its absolute discretion, but without being under any obligation to do so, update or supplement this Presentation. Any further information will be provided subject to the terms and conditions contained in this Important notices and disclaimer.

Acceptance

By accepting, accessing or reviewing this Presentation you acknowledge and agree to the terms set out in this section of the Presentation titled "Important notices and disclaimer". This Presentation may not be reproduced or published whole or in part, for any purpose without the prior written permission of AEM.



1

Introduction

Company Overview

Advanced Energy Minerals is a customer focussed, innovative producer of high and ultra-high purity alumina products serving attractive end-markets

Overview

- ✓ AEM is a producer of high purity alumina (HPA) from a **2,000 tpa** capacity production facility in Cap-Chat, Quebec, Canada.
- ✓ Listed on the ASX in Dec 2025 after successfully raising \$44.8m
- ✓ Serving the **rapidly growing global demand** in industries such as advanced ceramics, semiconductors, thermal fillers, and synthetic sapphire manufacture
- ✓ **On track to deliver 3,000 tpa** capacity with production from mid 2026 with the addition of a dedicated 3N5 circuit completing Stage 1
- ✓ Plans for a "Stage 2" expansion to 6,000tpa³ capacity from 2029
- ✓ At 3,000 tpa full production rate, the Plant will be the **3rd largest HPA production asset outside of China**¹
- ✓ CM Group forecasts AEM to be in the **bottom half of the global HPA cost curve** – benefitting from renewable hydroelectricity at **<US5c/kWhr**
- ✓ Industry leading Scope 1, 2 and 3 carbon emissions HPA supplier contributing less than 2.8t CO2e per tonne of production (~77% lower than incumbent producers)²

Key Metrics



6,000 tpa³

Nameplate Production



100%

Renewables Powered



59

Granted Patents



~5,500 tpa

Customer Pipeline



16 Projects⁴

Commercially Secured



>175 Projects⁴

In Qualification Trials

Cap-Chat Plant Expansion Project Snapshot

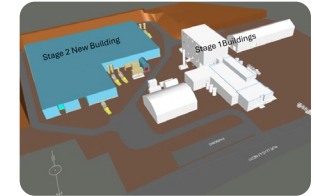

Stage	Stage 1	Stage 2
Location	Cap-Chat, Canada	
Status	Production Ramp Up	Pre-Feasibility Study (Completed June 2025)
Nameplate HPA Production Capacity	3,000 tpa ⁶	3,000 tpa
Current HPA Production Capacity (% nameplate)	<p>2,000 tpa 67%</p>	N/A
Next Steps	<ul style="list-style-type: none"> ▪ Dedicated 3N5 circuit delivering additional 1,000 tpa 	<ul style="list-style-type: none"> ▪ Stage 2 Definitive Feasibility Study due for completion in mid 2026
Production ramp up ⁵	From mid 2026	From early 2029

Notes: (1) CM Group based on capacities of HPA producers in 2024. (2) Optel (independent audit of AEM production operations and supply chain (completed in September 2023, updated July 2025)). (3) Following completion of both Stage 1 and Stage 2 of the Cap-Chat Plant. (4) Project: Customer's process to qualify and, if successful, then buy product for a specific application. (5) Current estimated project completion dates remain subject to change. (6) 2,000 tpa 4N+ and 1,000 tpa 3N5.



2

HPA Market Overview

High-Growth Global Demand in HPA End-Markets

Inherent properties – high thermal conductivity, high melting point; extreme hardness & wear resistance, high mechanical strength; chemically stable; excellent electrical insulation, transparent to microwave frequencies

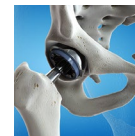
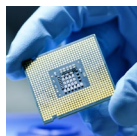

Applications

Synthetic Sapphire

Electronics and Semiconductors

Batteries

Other and Emerging Applications

Description	<ul style="list-style-type: none"> Used to produce high-quality sapphire crystals and sapphire substrates with specific quality and physical requirements 	<ul style="list-style-type: none"> Used in semiconductor fabrication across multiple phases of the manufacturing process 	<ul style="list-style-type: none"> Used to produce cathode materials (coating & doping) and anode coating 	<ul style="list-style-type: none"> Industrial roles where chemical resistance, thermal stability and hardness are crucial 																								
Examples	<ul style="list-style-type: none"> ✓ LED substrates ✓ Optical chips ✓ Watch faces ✓ Smartphone home buttons ✓ Camera cover plates 	<ul style="list-style-type: none"> ✓ Chemical mechanical polishing ✓ Substrate manufacturing ✓ Thermal fillers and interface management ✓ Etching chambers and masks ✓ 5G components 	<ul style="list-style-type: none"> ✓ EV batteries ✓ Consumer electronics batteries ✓ Grid energy storage systems ✓ Emerging battery applications (solid-state and sodium-ion) 	<ul style="list-style-type: none"> ✓ LEDs ✓ Transparent ceramics ✓ Medical ceramics ✓ Polishes and coatings 																								
Total 4N / 4N+ HPA Demand (kt)	<table border="1"> <tr><th>Year</th><th>Demand (kt)</th></tr> <tr><td>2024E</td><td>21.5</td></tr> <tr><td>2034F</td><td>56.4</td></tr> </table>	Year	Demand (kt)	2024E	21.5	2034F	56.4	<table border="1"> <tr><th>Year</th><th>Demand (kt)</th></tr> <tr><td>2024E</td><td>7.8</td></tr> <tr><td>2034F</td><td>20.3</td></tr> </table>	Year	Demand (kt)	2024E	7.8	2034F	20.3	<table border="1"> <tr><th>Year</th><th>Demand (kt)</th></tr> <tr><td>2024E</td><td>3.4</td></tr> <tr><td>2034F</td><td>8.9</td></tr> </table>	Year	Demand (kt)	2024E	3.4	2034F	8.9	<table border="1"> <tr><th>Year</th><th>Demand (kt)</th></tr> <tr><td>2024E</td><td>7.8</td></tr> <tr><td>2034F</td><td>20.2</td></tr> </table>	Year	Demand (kt)	2024E	7.8	2034F	20.2
Year	Demand (kt)																											
2024E	21.5																											
2034F	56.4																											
Year	Demand (kt)																											
2024E	7.8																											
2034F	20.3																											
Year	Demand (kt)																											
2024E	3.4																											
2034F	8.9																											
Year	Demand (kt)																											
2024E	7.8																											
2034F	20.2																											

Source: CM Group 2025.



Semiconductors – exceeding CM Group estimates

Data centres and AI is driving chip demand, performance improvements, and rapid increase in use of HPA, and ultra-low alpha HPA

FABRICATION

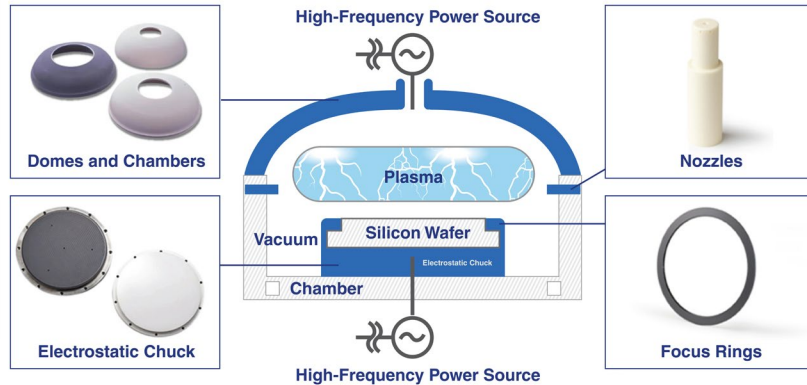

Ceramic Objects
2026 to 2029 growth 100 tpa 4N

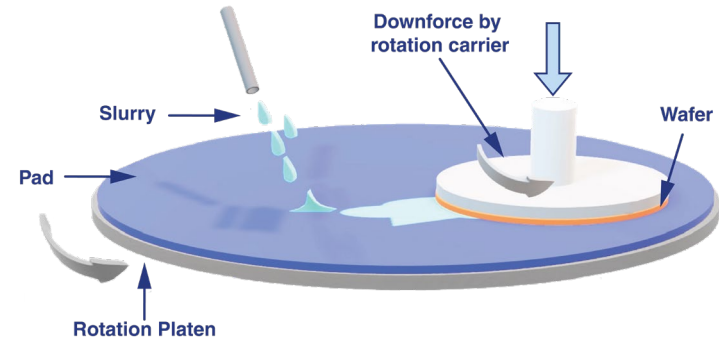

Chemical Mechanical Polishing (CMP)
2026 to 2029 growth 600 tpa HPA

ASSEMBLY

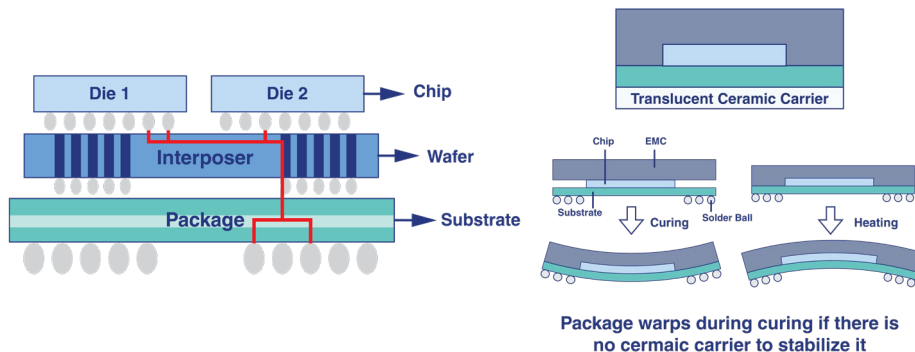

Translucent Ceramic Carriers
2026 to 2029 growth - 1,350 tpa HPA 4N

OPERATION

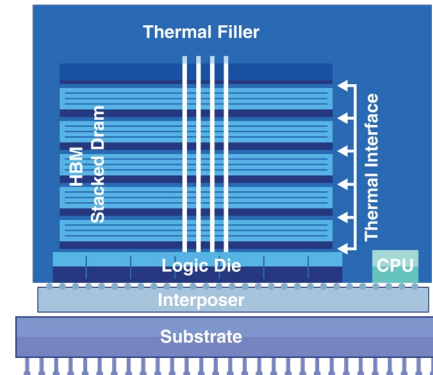

Thermal Fillers & Interface Management
2026 to 2029 growth - 4,235 tpa¹ HPA ~ 40% ultra-low alpha

Source: Advanced Energy Minerals, TSMC, (1) Alpha HPA



Overview of Global HPA Supply

China is the largest producer with production geared toward internal synthetic sapphire - imports approximately 2,000 tpa HPA for demanding applications

Capacities of HPA Producers in 2024

Tonnes per annum

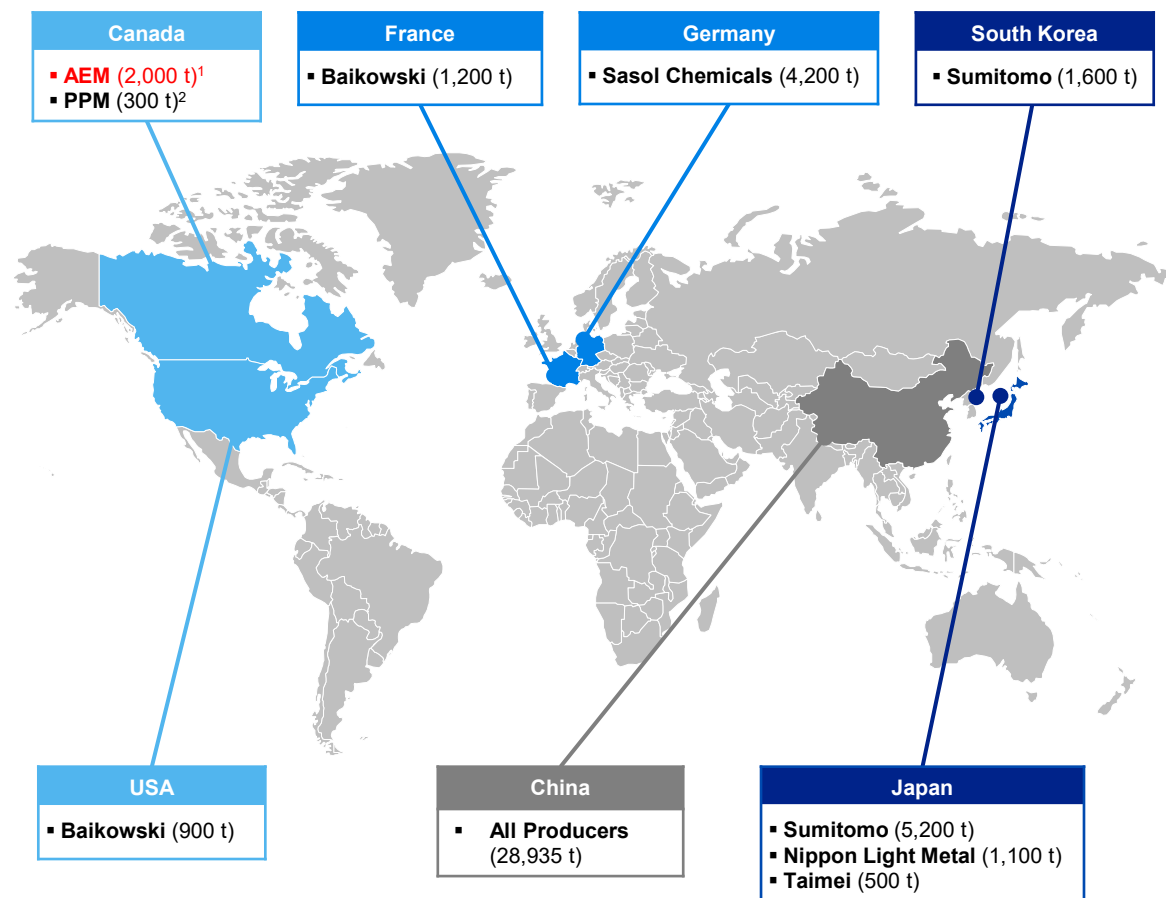

Breakdown of Global Supply³

4N+ HPA Supply in 2024, % of total market

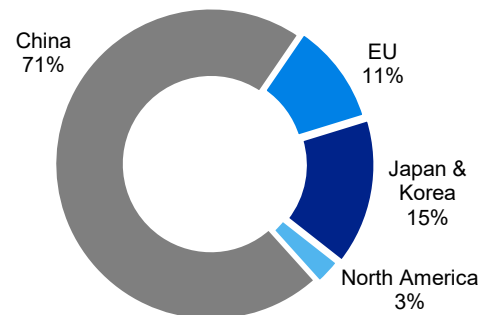

Ex China Global Supply Breakdown^{1,2,4}

Capacities of ex China HPA Producers in 2024, tpa

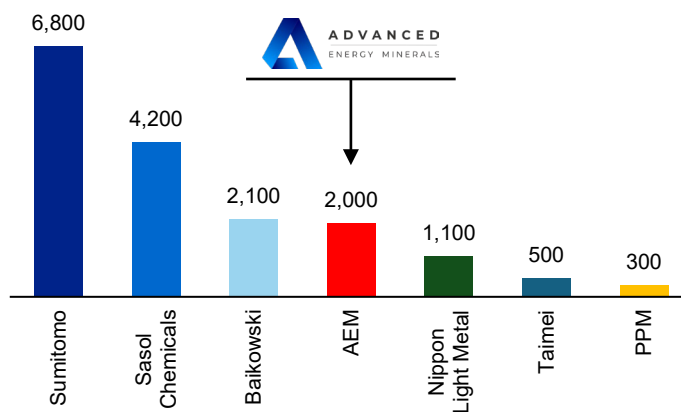

Source: CM Group report for AEM 2025 IPO.

Notes: (1) Current Advanced Energy Minerals production capacity (2) PPM – Polar Performance Materials. (3) As at 2024, prior to AEM achieving 2,000 tpa production capacity. (4) Sumitomo combines South Korea and Japan assets.

HPA Demand and Supply Dynamics

Strong demand growth combined with sluggish side supply response to lead to a sustained supply deficit from 2029

Global HPA Supply and Demand Outlook

Kilotonnes per annum, 4N/4N+ HPA

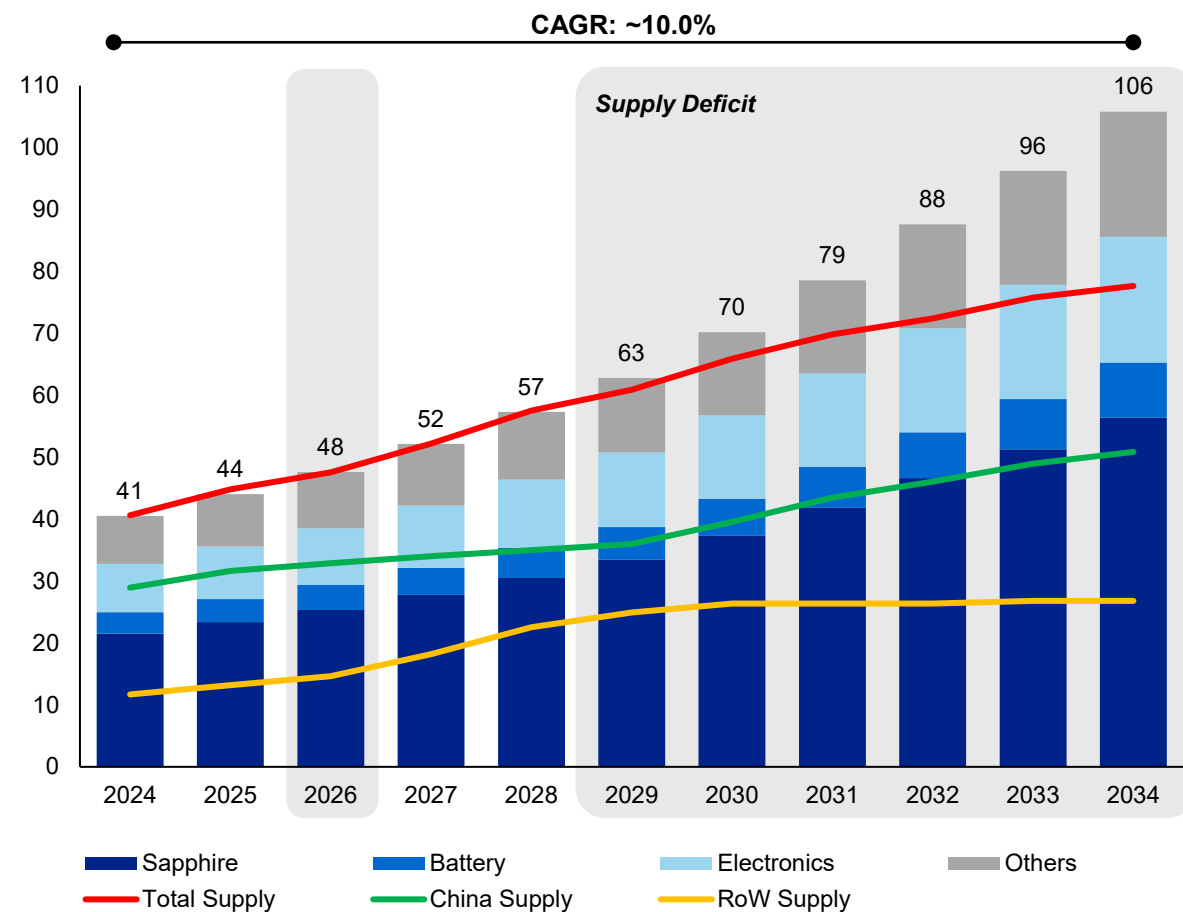

Source: CM Group report for AEM 2025 IPO.

Note: (1) As at 2024, prior to AEM's Cap-Chat Plant achieving 2,000 tpa production capacity.

Overview

- Strong global demand of 13.6% CAGR from 2013 to 2024, driven by strong demand in new industrial applications, in particular sapphire/LED manufacturing
- Global demand growth forecast to continue to grow strongly at double-digit CAGR (~10.0%) over the 10-year period from 2025 to 2034 driven by continued strong demand from the key sapphire and LED market with notable growth areas from the semiconductor sector
- A sluggish supply response means a supply deficit is forecast in 2026, and again persistently from 2029
- HPA made in China stays in China. China is expected to continue to be excluded from rest of world markets, due to quality, intellectual property, supply chain risk, and market opaqueness concerns
- Customers keen to encourage new supply due to concerns of future availability for new projects
- Production in 2024 of 4N/4N+ HPA outside China is considered closely approximated to actual capacity
 - Total supply ex. China is estimated to be 15.3 ktpa¹ mainly derived from producers in Japan, France and Germany
 - Sumitomo is currently the market leader (accounting for 6.8 ktpa (~44%) of ex. China supply)



HPA Pricing Dynamics

Tight market conditions and forecast undersupply expected to drive meaningful increase in HPA pricing

HPA Pricing Dynamics



4N/4N+ HPA Pricing Forecast (CM Group 2025)

HPA Product Pricing (US\$/kg)

Form	Region	2025	2026	Long-term
Rest of World Gamma HPA	Japan	18.0	22.0	30.0
	EU	18.0	22.0	30.0
Rest of World HPA Spec 1	All Regions ¹	21.0	30.0	38.0
Rest of World Milled HPA (4N5+)	Japan	25.0	32.5	40.0
	EU	25.0	32.5	40.0
Rest of World HPA Pucks	Japan	29.0	41.0	46.0
	EU	36.0	41.0	46.0
Rest of World Nano HPA	Japan	45.0	50.0	50.0
	South Korea	50.0	50.0	50.0

AEM Core Product

Commentary

- Customers behaviour indicates tight market conditions currently and discussions indicate concern about securing supply for new projects
- HPA markets currently attract high prices and are likely to continue to do so through the medium term
- The emergence of a new market sector for marginally lower HPA grades in the quality range 3N5 to 3N8 HPA attracts prices which are typically discounted by 40% to 50% relative to 4N/4N+ prices, depending on the specific quality requirement and application
- Strong demand growth outlook for several key HPA market sectors, a widening supply deficit and several significant barriers to entry, particularly around access to commercially proven production technology, provide pricing tailwinds

Source: CM Group report for AEM 2025 IPO.

Note: (1) All regions comprises Japan, EU, South Korea and USA.

Global Industry Production Cost Curve

CM Group estimates AEM to have lower production costs than rest of world producers while delivering the same or higher quality HPA product

Historically

Dominated by two distinct groupings:

- **China:** low-cost producers but cannot match quality of international peers
- **Rest of World (ROW):** producers in Japan, South Korea and the EU have significantly higher cost, on account of higher energy and labour costs

Today

- New ROW producers (AEM) are entering the HPA 4N/4N+ market
- Utilising innovative low-cost technologies (such as chlorine leach) have demonstrated an ability to deliver an equivalent ROW quality product at a materially lower cost base

Outlook

- A clear new 'step' will emerge in the global cost curve, between new, low-cost production and legacy, higher cost producers
- New producers entering the market at low cost (<US\$10,000/t) can take advantage of prices influenced by legacy producers

Forecast Global HPA Commercial Scale Production Cost Curve by Technology 2030

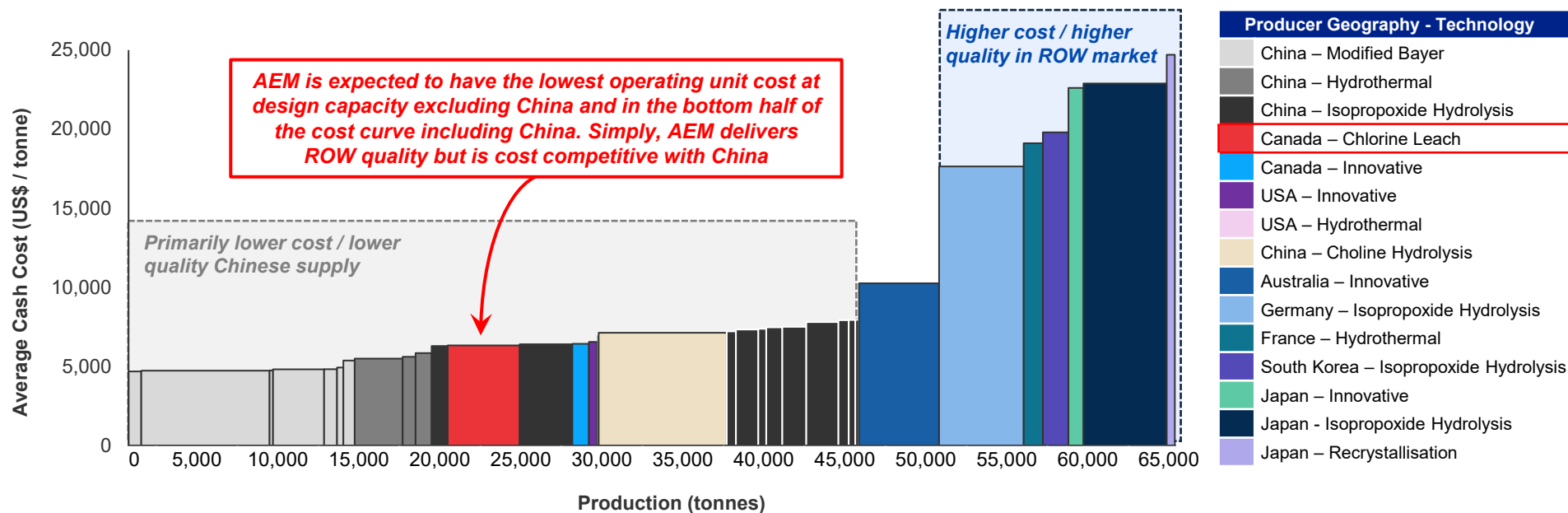

Source: CM Group report for AEM 2025 IPO.





3 Company Overview and Plant Expansion

Strategically Located Operations

The Cap-Chat Plant is in the Canadian Province of Quebec, benefiting from a stable, advanced economy, locally sourced feedstock, and low-cost renewable energy

Map of Canadian Operations



Cap-Chat Plant



Technology Development Centre



Rio Tinto Canadian Operations

Operational Advantages

- ✓ Politically stable and business friendly jurisdiction
- ✓ Educated and skilled workforce at moderate cost
- ✓ Access to low-cost renewable energy. Hydro Quebec supplies the plant with electricity at less than US5c/kWh – the Plant is wholly electrically powered
- ✓ Multiple possible sources of aluminous feedstock for the Company's manufacturing process from Quebec's aluminium industry including from its preferred supplier, Rio Tinto Alcan
- ✓ Funding available to support capital investment related to the exploitation of strategic minerals and the economic development of Quebec more generally^{1,2}

Notes: (1) AEM has secured project finance facilities from Investment Quebec of C\$7 million and Economic Development Canada of C\$2.0 million. (2) Federal and provincial government support includes a 25% capex rebate and tax credits for R&D in new materials (in FY24).



The Montreal Technology Development Centre

Creating processes to produce next-generation materials for critical supply chains

Continued focus on innovation in production process...

AEM's Montreal Technology Development Centre comprises:



State-of-the-art
Laboratory



Advanced Analytical
Equipment



Leading Research
Scientists

Innovation process underpinned by customer collaboration:

Support of
operations during
product qualification

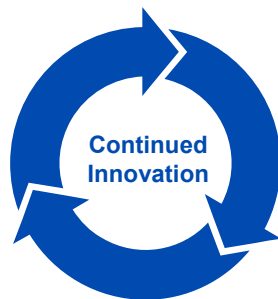

Working with
research institutions
on process and
product
development

Development of
optimised and new
products in collaboration
with customers

...driving further strategic and financial benefit to AEM

1 Competitive Positioning

- ✓ Enhances intellectual property portfolio with proprietary production technologies
- ✓ Develops production processes, such as:
 - ✓ Ultra-low alpha HPA
 - ✓ nano-particle HPA, including REE doped
 - ✓ stable HPA slurries,
 - ✓ novel approaches to making HPA monoliths for synthetic sapphire

2 Margin Expansion

- ✓ Optimisation of product portfolio to focus on highest margin products
- ✓ Development of lower-energy, lower-cost, and environmentally sustainable HPA production processes, unlocking opportunity for further operational efficiencies and margin expansion

3 Customer Responsiveness

- ✓ Supports operations and sales teams with product qualification
- ✓ Accelerates product optimization in response to customer engagement

Stage 1 Project Overview

AEM has successfully delivered a commercial scale plant with an HPA production capacity of 2,000 tpa, and will complete Stage 1 with an additional 1,000 tpa capacity in 2026

Pathway

<p>✓ Complete</p>	<ul style="list-style-type: none">✓ AEM successfully delivered the Stage 1 Expansion program 2023-2025 delivering commercial scale production capacity of 2,000 tpa - commissioned and independently validated✓ Plant modifications completed early 2026 to produce ultra-low alpha HPA primarily for the semiconductor sector.✓ AEM is now well placed to progressively ramp-up production to meet growing global demand
<p>➔ Current Work Programme</p>	<ul style="list-style-type: none">▪ Expansion of the Cap-Chat Plant's capacity by 1,000 tpa via the installation of a dedicated 3N5 HPA circuit with production from mid-2026.▪ Installation of additional product tailoring equipment in the Plant's Final Processing section to cater to the evolving production mix▪ Ramp up the Plant to full production to meet expected sales demand growth through 2026/2027

Tunnel Kiln In Operation

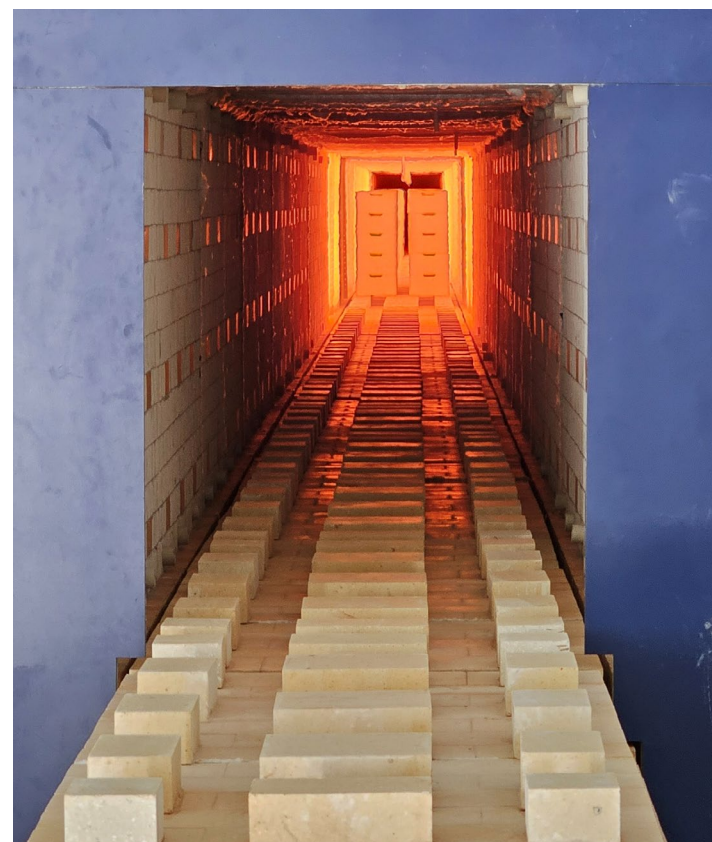

Source: WSP Independent Engineer's Report: Cap-Chat Plant and Stage 1 Expansion (September 2025).

Stage 2 Expansion Project Overview

AEM has plans to double capacity to 6,000 tpa through a Stage 2 Expansion Project, which would be located adjacent to the existing Stage 1 Plant

Expansion Project Overview

Positive Stage 2 PFS¹ Completed

- Stage 2 expansion PFS completed in June 2025. DFS due for completion in Q3 with revised scope including integration with current plant and product mix.

Doubling Production Capacity

- AEM's total production capacity at completion will double from 3,000 tpa to 6,000 tpa. Staged expansion strategy benefits from Stage 1 operations ramp up ahead of Stage 2 FID³

Reduced Execution Risk

- Land, raw materials and infrastructure are available to develop Stage 2 adjacent to the existing Stage 1 plant

Expansion Forecast to Match Demand

- Construction to commence in early 2027 to match anticipated market demand and complete all critical external works before the following winter

Robust Economics

- PFS indicates steady state EBITDA ranges between ~US\$47.1 million to ~US\$85.2 million per annum at a margin of ~74.0% to ~83.7% at steady state

Government Support & Debt Funding Optionality

- Robust economics suitable for material debt funding component and Quebec government capex rebates potentially available

Stage 2 PFS Metrics at Steady State Production

Financial Metrics Based on Pre-Feasibility Study

		1	2
	Units	CM Group Current Pricing	CM Group Long-Term Pricing
Stage 2 Expansion Project Capex			
Initial Capex ¹	US\$m	215.0	215.0
Steady State Metrics (From 2032)			
Production Volume	tonnes	~3,000	~3,000
Weighted Product Price	US\$/kg	21.3	34.0
Revenue²	US\$m	63.6	102.0
Variable Costs ³	US\$m	10.1	10.1
Fixed Costs ³	US\$m	6.5	6.5
Total Opex	US\$m	16.6	16.6
Unit Cash Cost	US\$/kg	5.5	5.5
EBITDA⁴	US\$m	47.1	85.2
Margin	%	74.0%	83.7%

Source: WSP Independent Technical Report - Pre-Feasibility Engineering Cap-Chat Plant Stage 2 Expansion (September 2025), CM Group, BDO, Advanced Energy Minerals.

Notes: (1) Capex estimate of ~C\$298.8 million as at Q4 2024 prices. Capex estimate does not take account of the effects of cost escalation or the corporate costs that AEM would incur in connection with the Project. Capex estimate for Stage 2 converted to US\$ at an exchange rate of ~0.72 US\$ / 1.00 CA\$. Does not include sustaining capex required for ongoing plant operation. (2) Production Volume x Weighted Product Price (3) Opex estimate for Stage 2 across forecast period based on 91% run rate utilisation for plant production converted to US\$ at an exchange rate of ~0.72 US\$ / 1.00 CA\$. (4) Any discrepancies between totals and sums of components are due to rounding.

Staged Ramp Up and Expansion Plan Timetable

A clear path to 6,000 tpa HPA capacity by 2029

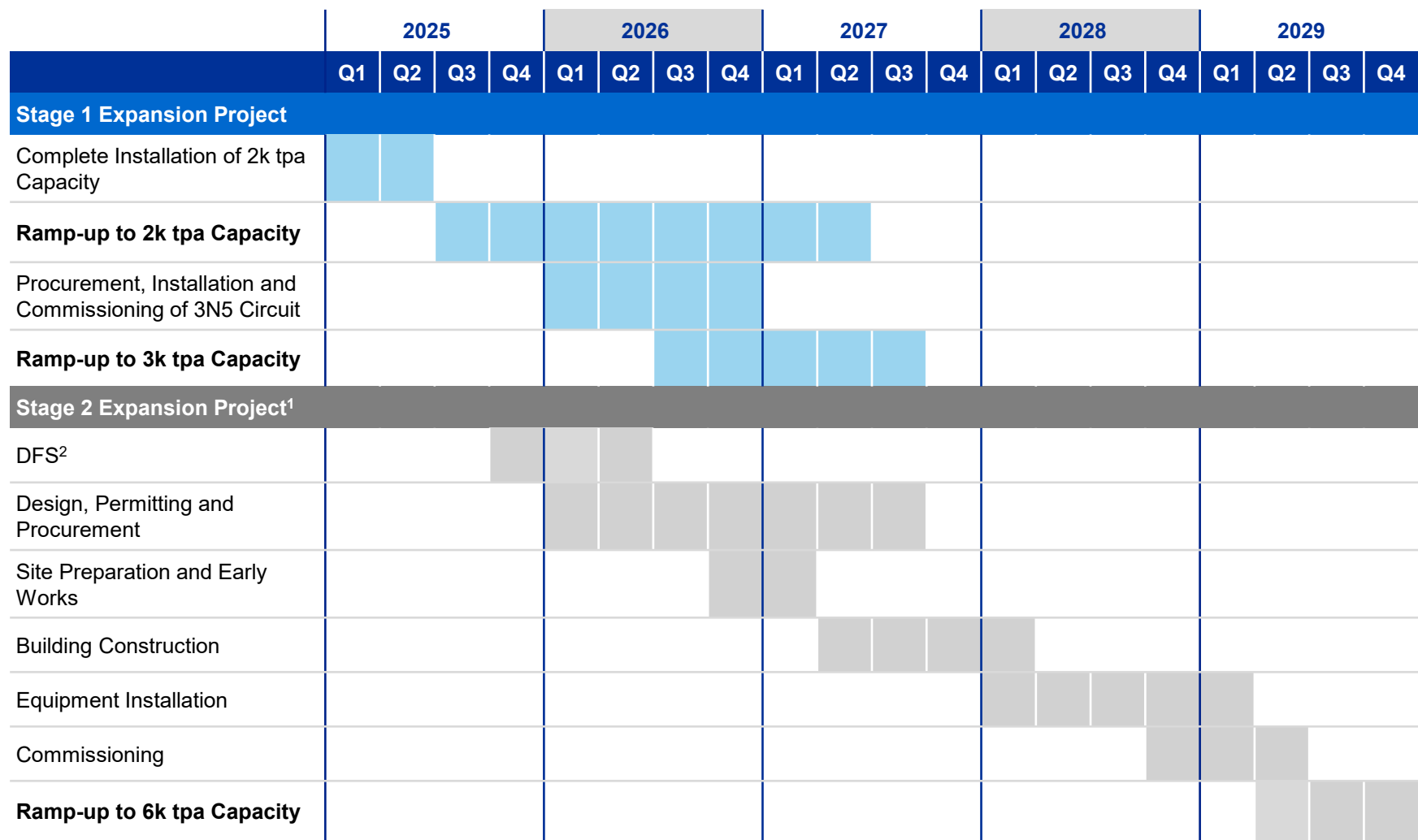

Conservative ramp-up to Q2 2031

Notes: (1) The above timetable is based on the Stage 2 PFS and certain assumptions. The timetable is indicative only and remains subject to change. (2) DFS – Definitive Feasibility Study.



4

Sales and Marketing

Global Sales Infrastructure

Dedicated in-house sales team with deep industry and sales experience complemented by a global network of distributors and agents

Global sales infrastructure in place...

In-house Sales Team

■ Europe ■ North America ■ Asia

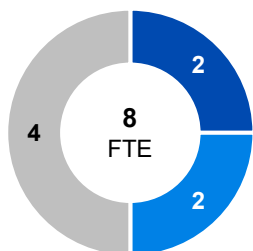

Distributors / Agents

■ Europe ■ North America ■ Asia

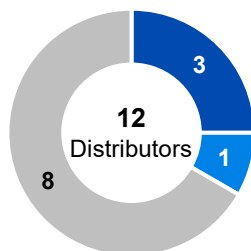

■ In-house and distributor end-market coverage

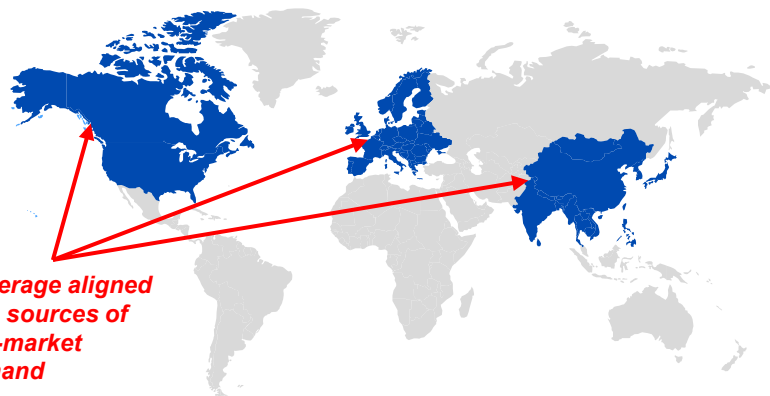

Coverage aligned with sources of end-market demand

...providing robust coverage of end-markets

	In-house Sales Team	Distributors / Agents
Overview	<ul style="list-style-type: none"> Led by Frankfurt-based Dr Daniele Fregonese Team possesses deep industry and sales experience Strong relationships and well connected with industry participants 	<ul style="list-style-type: none"> Independent reselling to end customers Coverage across USA, Europe and Asia
Advantages	<ul style="list-style-type: none"> ✓ Deep product knowledge to drive conversion ✓ Direct customer feedback to iterate sales process ✓ Stronger margin profile ✓ Nurture strategic accounts for growth 	<ul style="list-style-type: none"> ✓ Broad reach across verticals and geographies ✓ Leverage existing networks ✓ Rapidly expand market presence
Target Customers	<ul style="list-style-type: none"> Large international and market leading accounts 	<ul style="list-style-type: none"> Existing and smaller end-customers
Sales Channels / Example Distributors	<ul style="list-style-type: none"> Trade shows Database direct communications LinkedIn Sapphire Green Alliance 	

Customer Pipeline

The customer pipeline overall has continued to grow since December with increase in industrial trials reflecting customer interest in ultra low alpha HPA

Focus on commercialisation has forged a robust customer pipeline...

~US\$148m¹
potential annual value

~5,500
tonnes per annum

~US\$26.9/kg
average price

Value in US\$ millions

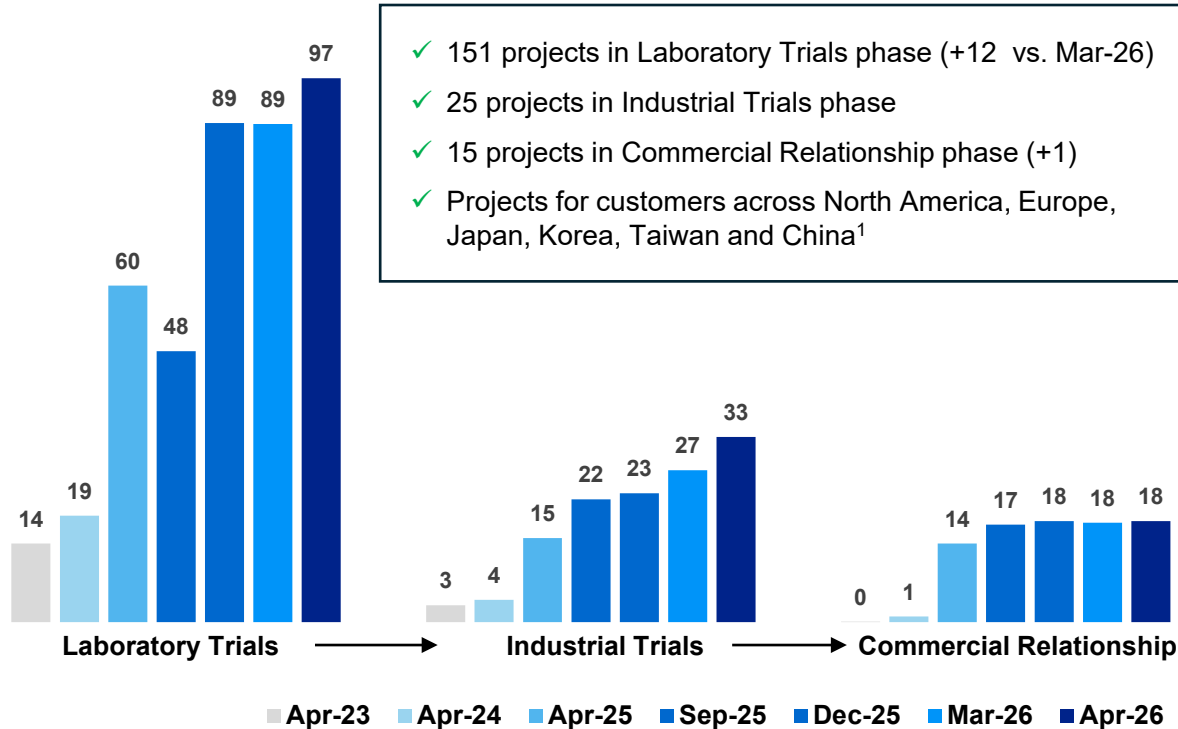

...with customers seeking AEM's...

- ✓ High purity product
- ✓ Flexible and collaborative product development
- ✓ Sustainable product process to meet evolving ESG requirements
- ✓ Canadian plant location ensuring stability and security of supply
- ✓ Delinking from China
- ✓ Stable cost base, independent of oil prices

Notes: (1) Un-risked basis comprising ~3,900 t of 4N+ and ~1,600 t of 3N5+ HPA

Examples of Qualification Process

HPA has a wide range of downstream applications, and the qualification processes required by customers can vary significantly, due to differences in product types and application scenarios

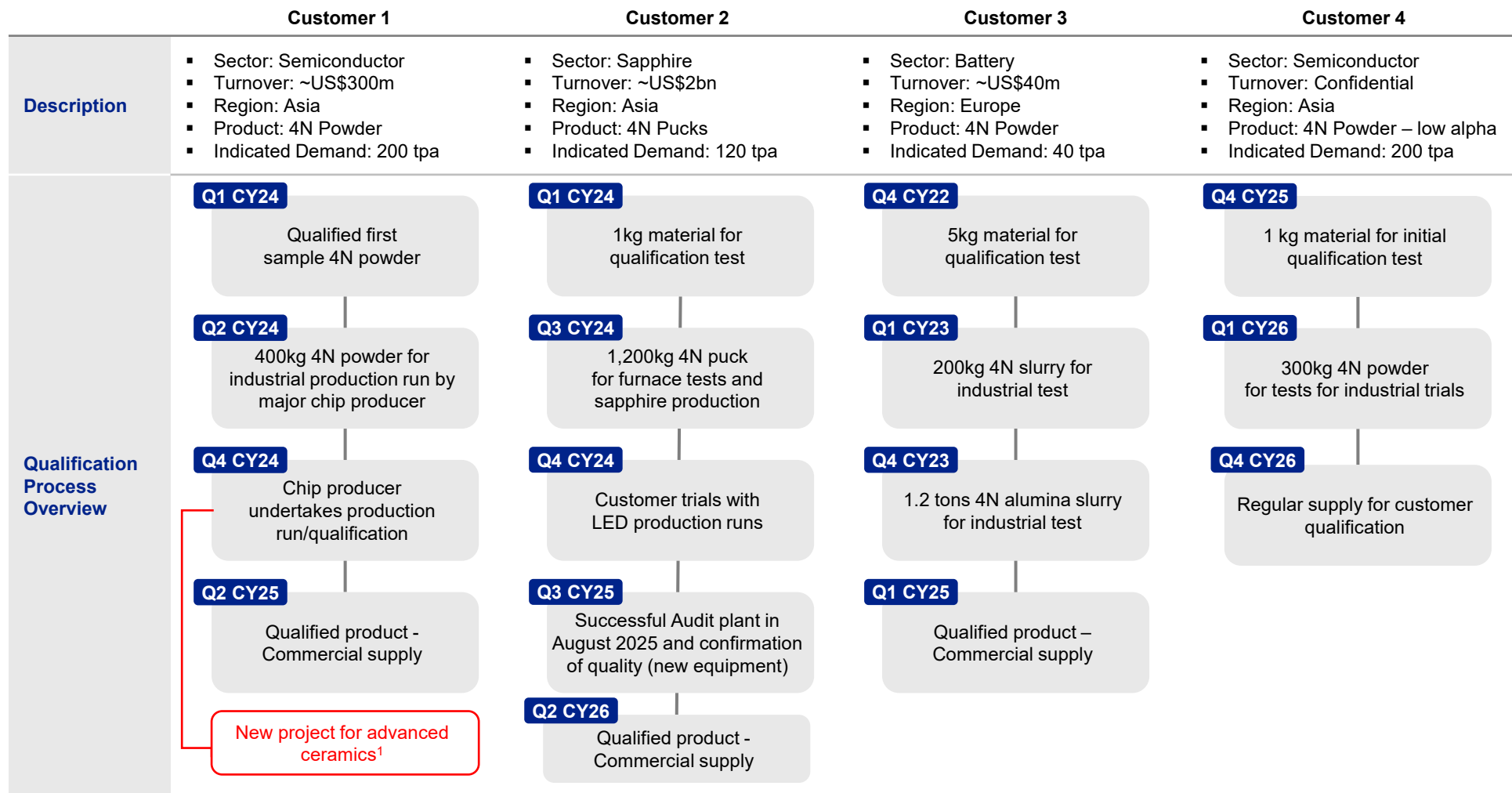

Note: (1) Project: Customer's process to qualify and, if successful, then buy product for a specific application.



5 Management



Management Team

AEM's management team has the requisite skills and experience to oversee plant development and long-term operational success

Key Management



Richard Seville
Executive Chairman



Michael Adams
Managing Director / CEO



Alexis Clark
Chief Financial Officer

- Executive Chairperson of AEM since Jan 2022
- Highly successful track record in the junior to mid-cap resources space
- Over 25 years as a Director of various ASX, TSX or AIM listed companies (including Allkem Limited, Oz Minerals and Agrimin Ltd)
- Took Allkem from IPO in 2007 to a significant producer of lithium chemicals and part of the battery supply chain

- Joined AEM Board in Jan 2021, became a full-time employee and was appointed Managing Director and CEO in May 2021
- Now based in Cap-Chat
- Professionally qualified chartered engineer with over 40 years of experience
- Experience in developing, financing and building major infrastructure projects at Trafalgar House, Kvaerner and Gammon Construction

- Over 20 years international finance experience
- Previously worked at Merrill Lynch and Patersons (now Canaccord) in equity research covering the Australian energy sector
- Background in originating and executing structured finance transactions for infrastructure, resources and energy companies

Supported by a deeply-experienced senior management team...



Stephane Blanchette
Chief Human
Resources Officer



Sylvain Sayer
SVP – Production and
Asset Management



Dr Daniele Fregonese
SVP – Sales and
Marketing



Dr Ebrahim Alizadeh
SVP – Technical Services
and R&D



Dr Jean-Nicolas Beaudry
SVP – Corporate
Development & Strategy



6 Closing Remarks



Investment Highlights

1 Emerging Leader in HPA

- ✓ Innovative HPA producer capable of producing both purity levels up to 5N (99.999%) and uranium levels less than 1ppb
- ✓ Commercial scale capacity of 2,000tpa at the Cap-Chat Plant delivered in 2025 placing AEM among world's leading HPA suppliers

2 Innovative and Sustainable Production

- ✓ Patented process powered 98% by renewables at >US\$0.05/kWhr and enabled by locally sourced feedstock
- ✓ Forecast to be in the bottom half of the global industry cost curve including China while producing high purity product¹

3 Strong Industry Tailwinds

- ✓ HPA is high growth market with a ~13.6% CAGR between 2013 and 2024 with forecast ~10.0% CAGR to 2034¹
- ✓ Leveraged to attractive high-tech markets and with strong tailwinds for HPA pricing driven by industry undersupply

4 Strategic Plant Expansion Plan

- ✓ Stage 1 will be completed with an additional dedicated 3N5 circuit in 2026 delivering a total of 3,000 tpa
- ✓ Stage 2 to deliver 6,000 tpa with PFS indicated robust project economics with steady state annual EBITDA of ~US\$47.1m to ~US\$85.2m²

5 Robust Customer Pipeline

- ✓ 16 customer projects⁴ commercially engaged and 176 under qualification trials
- ✓ Customer pipeline of ~US\$148 million per annum across North America, Europe, Japan, Korea, Taiwan, and China

6 Experienced Leadership with Proven Capability

- ✓ Experienced management team with a demonstrated track record of project construction and operational success
- ✓ Proven board led by Richard Seville (former MD and CEO of Allkem Lithium and NED³ of OZ Minerals)

Notes: (1) CM Group 2025. (2) Refer to assumptions outlined on page 27. (3) Non-Executive Director. (4) Project: Customer's process to qualify and, if successful, then buy product for a specific application.





ADVANCED

ENERGY MINERALS